



**ALLTRACK (MY24)**

**ALLTRACK 4 (MY24)**

**TREKKING 3 (MY24)**

ALLTRACK, ALLTRACK 4 & TREKKING 3 (MY24)

date: 24-10-2023

version: 01

# ÜBERSICHTSZEICHNUNG ASSEMBLY DRAWING



# LAPIERRE



**OVERVOLT HT 4.5 HIGH**  
**OVERVOLT HT 4.5 MID**  
**OVERVOLT HT 5.5 HIGH**  
**OVERVOLT HT 5.5 MID**

**E-EXPLORER 4.5 HIGH**  
**E-EXPLORER 5.5 HIGH**  
**E-EXPLORER 6.5 HIGH**

# HOW TO USE EXPLODED VIEW

BOM-ID	Description	Specification	Torque	QTY	Service Kit nr.
1	Counter sunk screw (Set)	IS2 - M3 x 8 mm	1 Nm	2	KHB00025  

“ You can click on the logo according to your part's supplier. It will take you to the purchase page. ”



A screenshot of a web browser showing a product page. The browser's address bar contains 'KHB00025'. The page header includes navigation menus for 'Commander', 'Info commandes', 'Service', 'Actu', 'Bilsons personnalisés', 'Aide Accentry', and 'Offres'. Below the header is a list of categories: 'Accessoires', 'Freins', 'Fourches et Suspension', 'Composants', 'E-Bike et Mobilité Urbaine', 'Électronique Et Lumières', 'Nutrition et soins', 'Vêtements et chaussures', 'Roues et pneus', 'Atelier et Entretien', and 'Transmission'. The breadcrumb trail reads: 'Accueil / Rechercher / Vélos / Service Kits / JEU DE SUPPORTS ENTRÉE DE CÂBLES MOTEUR YAMAHA E-BIKE HAIBIKE ALLTRACK GAUCHE/DROITE NOIR'. The main content area features an image of the product, which consists of two black plastic cable inlet supports and five small metal screws. To the right of the image, the product title is 'JEU DE SUPPORTS ENTRÉE DE CÂBLES MOTEUR YAMAHA E-BIKE HAIBIKE ALLTRACK GAUCHE/DROITE NOIR 2023'. Below the title, it says 'TRK ALLTRACK YAMAHA CABLE INLET SET' and lists the included items: 'Comprend: support d'entrée de câbles gauche et droite, vis.' The product details include 'Numéro d'article: KHB00025', 'Code-barres: 8715957603410', and 'Référence fournisseur: KHB00025'. A green 'Stock' indicator with a checkmark is visible. The price is listed as 'Prix public € 9,99'. At the bottom, there is a quantity selector set to '1' and a blue 'Commander' button.

# ASSEMBLY DRAWING

SERVICE FILE

main frame

# HAIBIKE

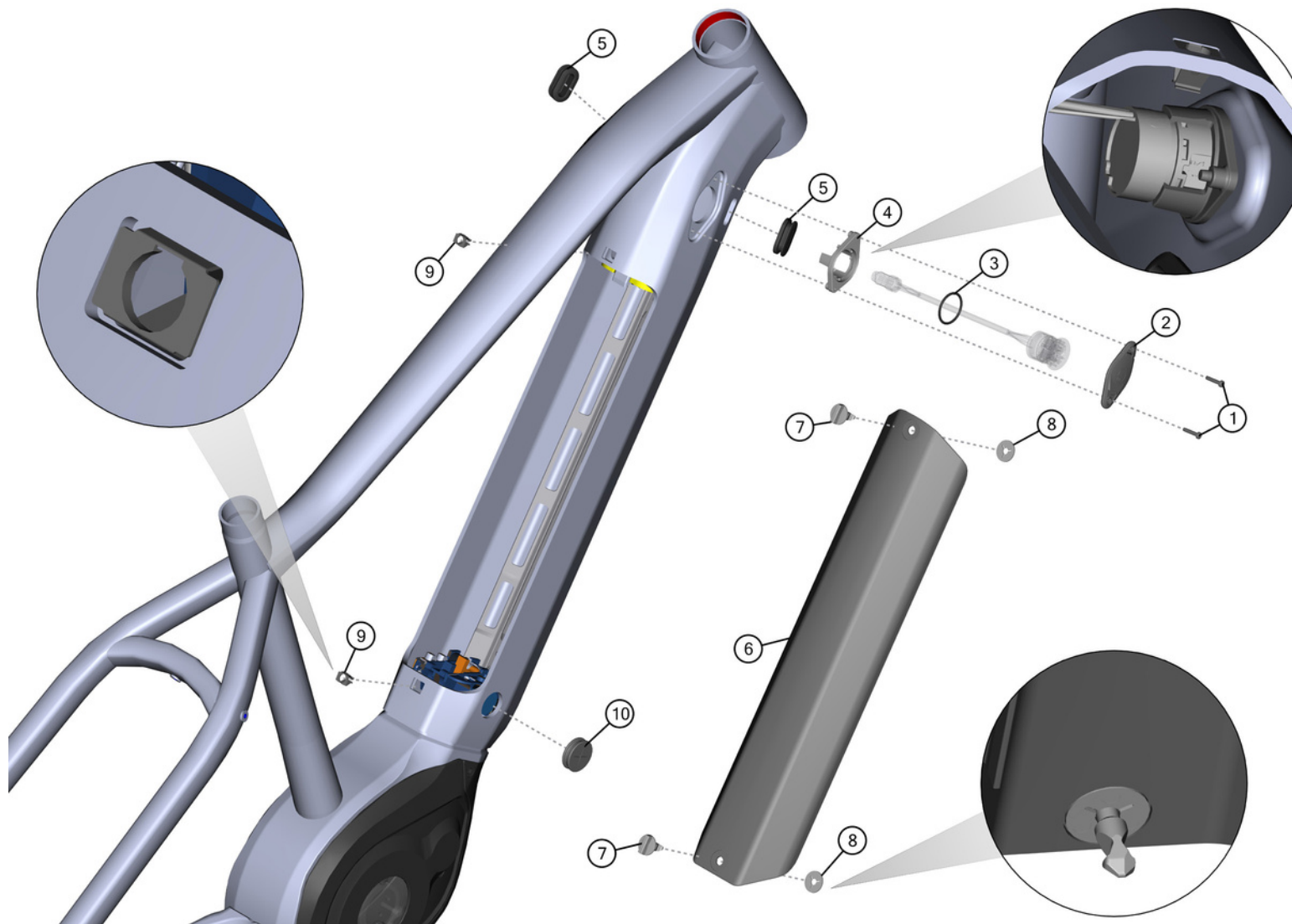

**Hinweis:** Bei den Schrauben muss mittelfeste Gewindegewissicherung verwendet werden.  
**Rote Flächen müssen gefettet werden.**

**Note:** use medium strength screw lock for screw threads.  
**Red surfaces have to be greased.**



$\frac{3}{4}$  medium strength screwlock

ALLTRACK, ALLTRACK 4 & TREKKING 3 (MY24)

date: 24-10-2023





















version: 01

# ASSEMBLY DRAWING

## SERVICE FILE

### main frame

# HAIBIKE

BOM-ID	QTY	Description	Specification	Torque	Service Kit
1	2	Self-tapping lens head screw	TX10 - M3 x 16 mm	1 Nm	KHB00028  
2	1	Charge port cover			KHB00075  
3	1	O-ring charge port			KHB00075  
4	1	Charge port frame			KHB00075  
5	2	Cable inlet rubber			KHB00050  
6	1	Battery cover			KHB00048  
7	2	Locking bolt (pin)			KHB00048  
8	2	Retaining disc (plastic)			KHB00048  
9	2	Metal clip			KHB00048  
10	1	Lock rubber for lock cylinder			KLP00028  

ALLTRACK, ALLTRACK 4 & TREKKING 3 (MY24)

date: 24-10-2023

version: 01

# ASSEMBLY DRAWING

SERVICE FILE

battery mount

# HAIBIKE

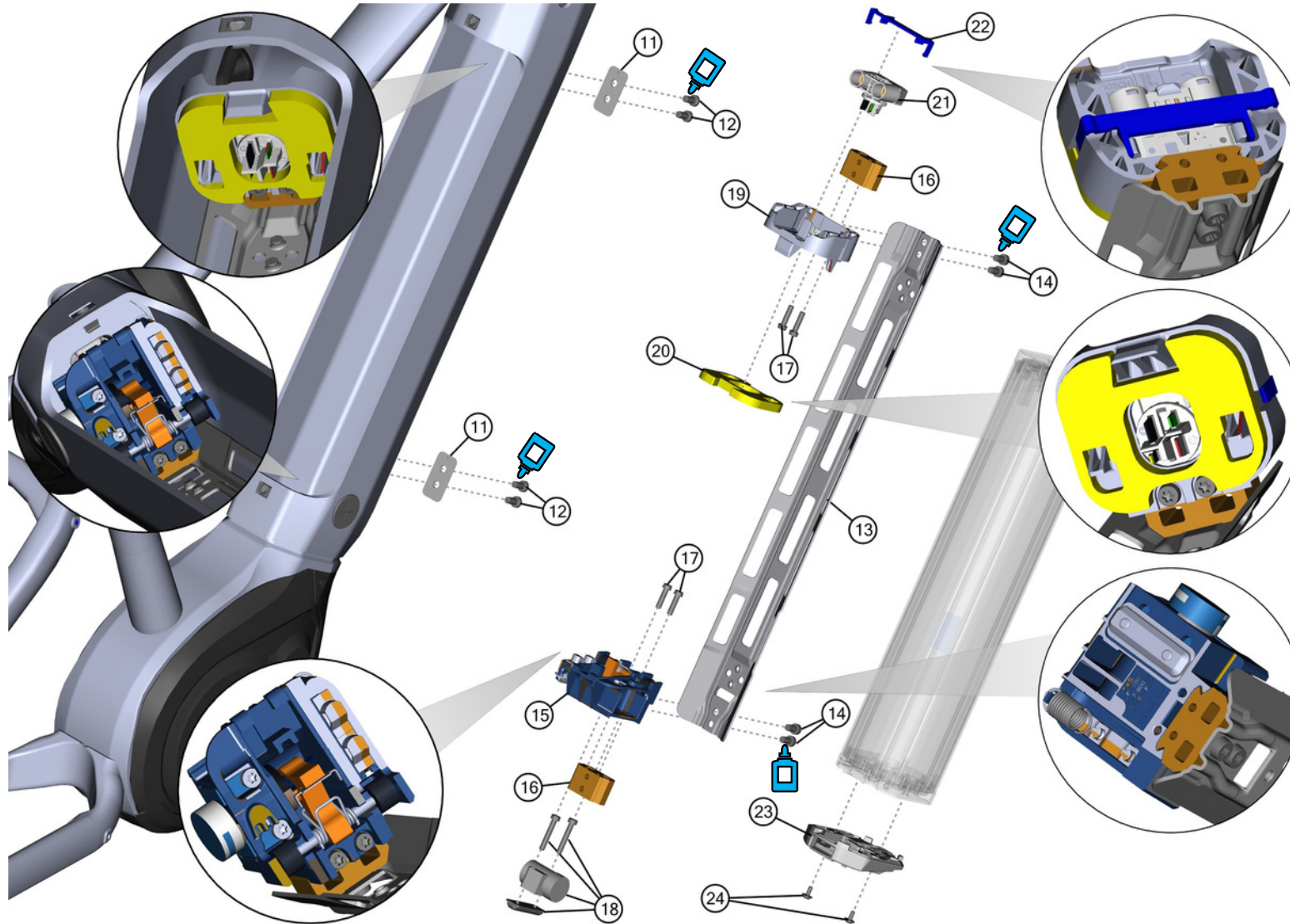

**Hinweis:** Bei den Schrauben muss mittelfeste Gewindegewandung verwendet werden.  
Rote Flächen müssen gefettet werden.

**Note:** use medium strength screw lock for screw threads.  
Red surfaces have to be greased.



$\frac{3}{4}$  medium strength screwlock

ALLTRACK, ALLTRACK 4 & TREKKING 3 (MY24)

date: 24-10-2023



version: 01

# ASSEMBLY DRAWING

## SERVICE FILE

### battery mount

# HAIBIKE

BOM-ID	QTY	Description	Specification	Torque	Service Kit
11	2	Battery mounting plate			
12	4	Cylinder head screw (flat head)	IS3 - M5 x 10 mm	5 Nm	
13	1	Battery rail			BOSCH EB12.100.01K
14	4	Cylinder head screw	TX25 - M5 x 9 mm	5 Nm	BOSCH EB12.100.01Y
15	1	Locking assembly			BOSCH EB12.100.01H
16	2	Frame base profile			BOSCH EB12.100.01W
17	4	Cylinder head screw	TX20 - M4 x 16 mm	3 Nm	BOSCH EB12.100.01X
18	1	Lock cylinder			KHB00049  
19	1	Cradle battery holder			BOSCH EB12.100.01U
20	1	Damper foil for cradle			BOSCH EB12.100.01Z
21	1	Battery plug adapter			BOSCH EB12.100.015
22	1	Clamp for cradle			BOSCH EB12.100.02D
23	1	Battery face plate			BOSCH EB12.100.01F
24	2	Lens head screw	TX15 - M3 x 7 mm	1 Nm	BOSCH EB12.100.01G

ALLTRACK, ALLTRACK 4 & TREKKING 3 (MY24)

date: 24-10-2023

version: 01

# ASSEMBLY DRAWING

SERVICE FILE

drive mount

# HAIBIKE

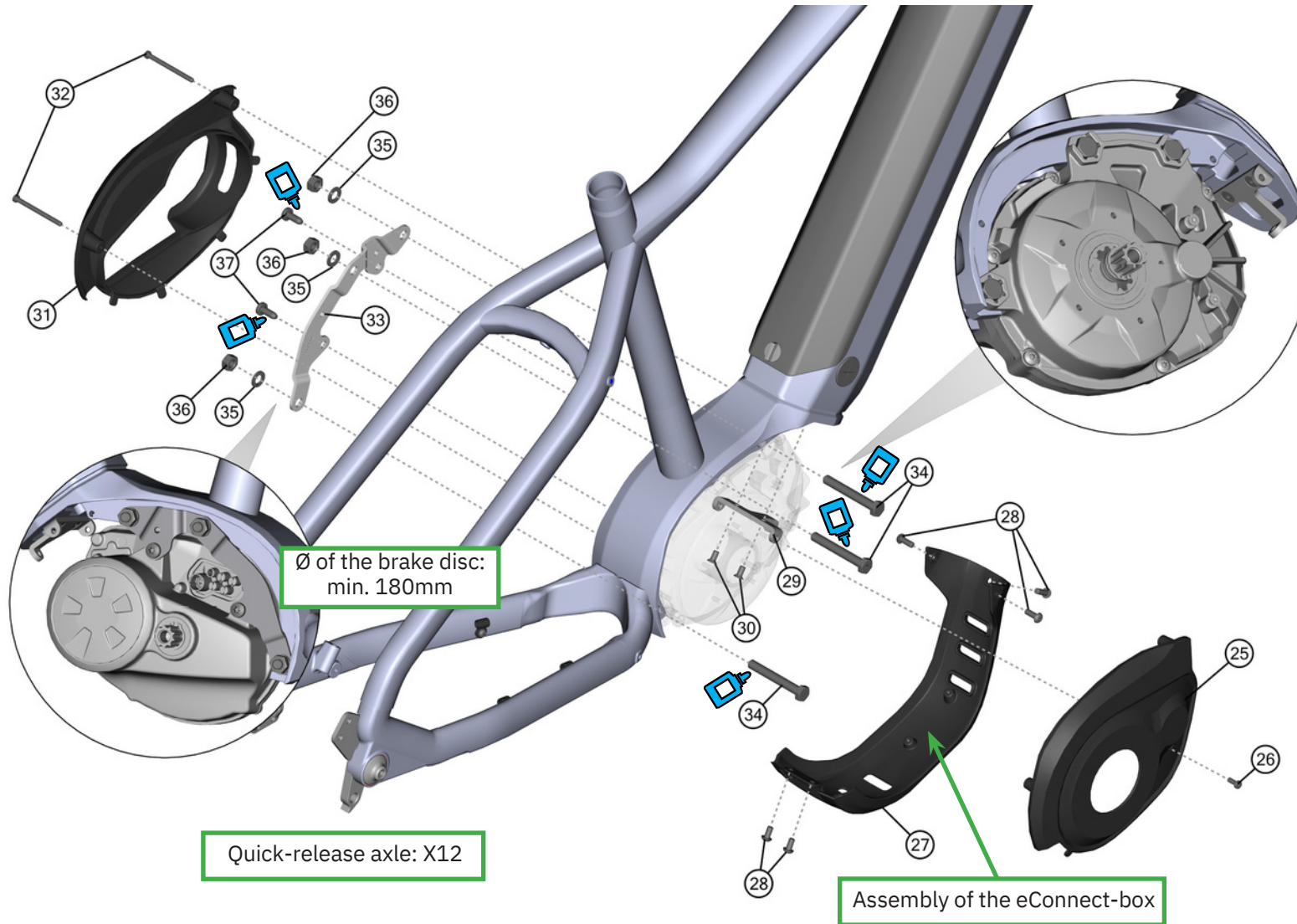

**Hinweis:** Bei den Schrauben muss mittelfeste Gewindegewissicherung verwendet werden. Rote Flächen müssen gefettet werden.

**Note:** use medium strength screw lock for screw threads. Red surfaces have to be greased.

 ¾ medium strength screwlock

ALLTRACK, ALLTRACK 4 & TREKKING 3 (MY24)

date: 24-10-2023

version: 01







# ASSEMBLY DRAWING

## SERVICE FILE

## drive mount

# HAIBIKE

BOM-ID	QTY	Description	Specification	Torque	Service Kit
25	1	Motor cover right			KHB00047 
26	1	Self-tapping lens head screw (flat head)	TX20 - M4 x 12 mm	3 Nm	
27	1	Motor skidplate			KHB00047 
28	5	Lens head screw	IS3 - M5 x 8 mm	6 Nm	
29	1	Cover mounting plate (T-Plate)			KHB00047 
30	2	Counter sunk screw	IS3 - M5 x 10 mm	6 Nm	
31	1	Motor cover left			KHB00047 
32	2	Self-tapping lens head screw	TX20 - M4 x 53,5 mm	3 Nm	BOSCH I270.016.420
33	1	Motor mounting plate			BOSCH EB11.200.03R
34	3	Hexagon head screw	M8 x 60	28 - 30 Nm	BOSCH 2911.029.258
35	3	Washer			BOSCH 2916.011.164
36	3	Nut	M8		BOSCH 2915.068.005
37	2	Lens head screw	TX30 - M6 x 16	9 - 11 Nm	BOSCH I270.016.426

➤ The noses of the motor cover right side and motor cover left side must be hung low on the inside of the motor skidplate!

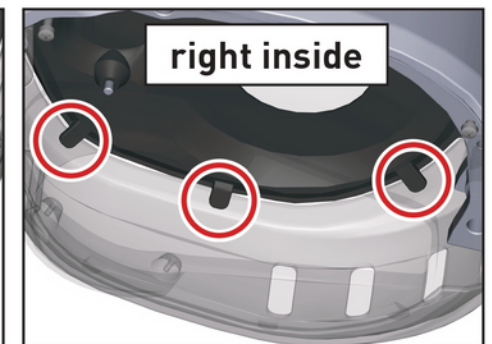
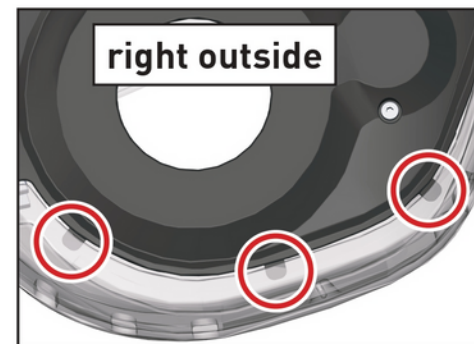
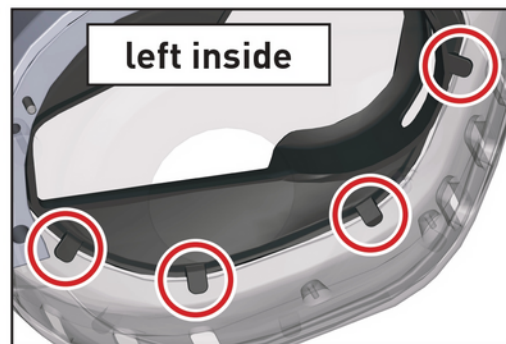
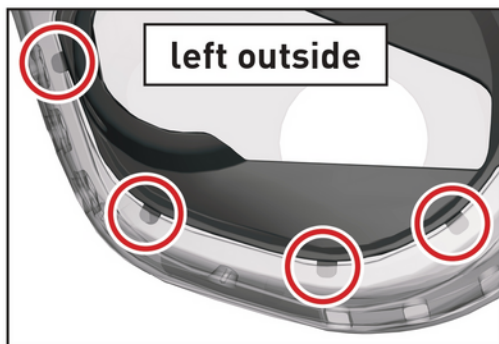

ALLTRACK, ALLTRACK 4 & TREKKING 3 (MY24)

date: 24-10-2023

version: 01

# ASSEMBLY DRAWING

SERVICE FILE

rear frame

# HAIBIKE

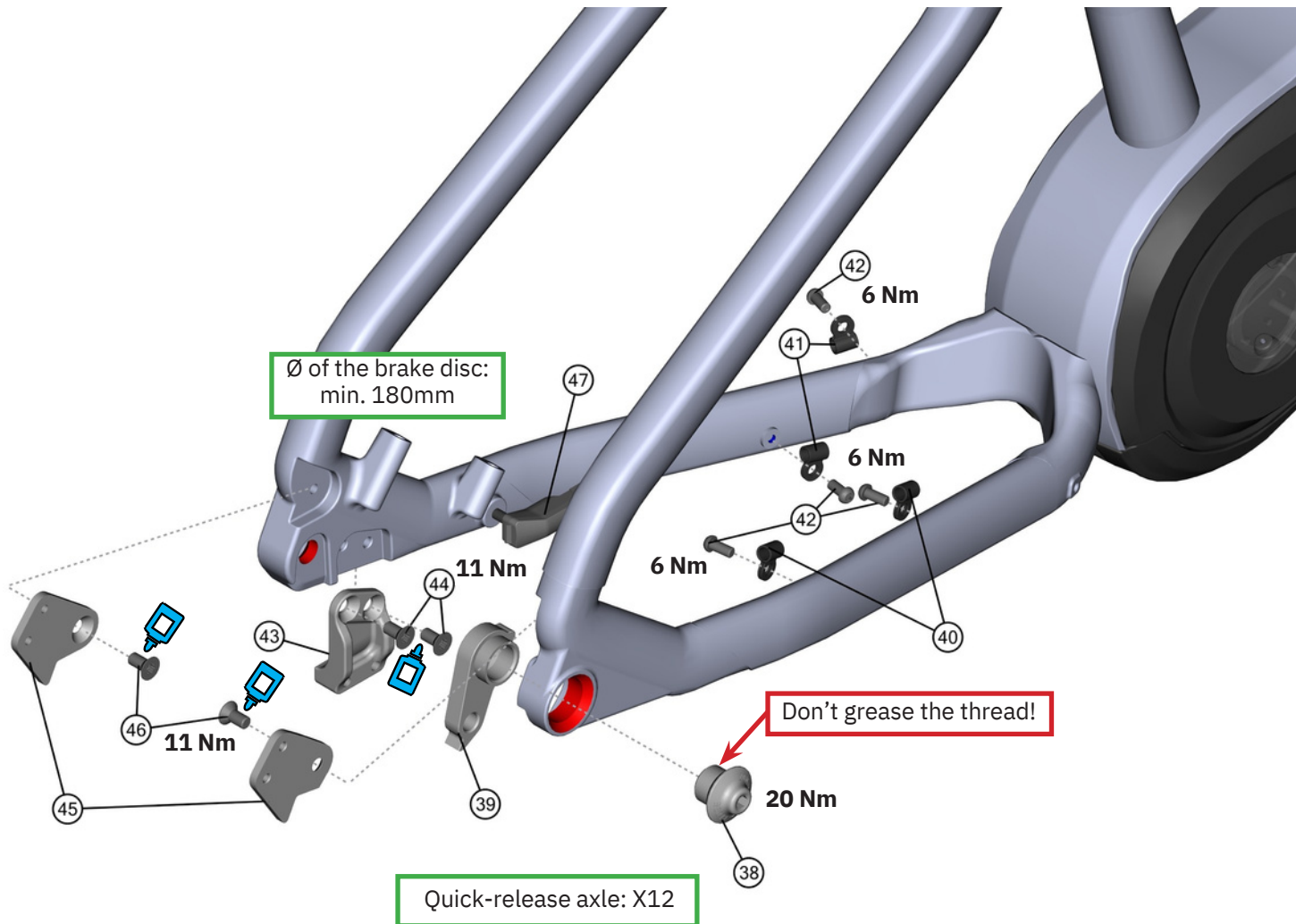

**Hinweis:** Bei den Schrauben muss mittelfeste Gewindegewissicherung verwendet werden. Rote Flächen müssen gefettet werden.

**Note:** use medium strength screw lock for screw threads. Red surfaces have to be greased.



$\frac{3}{4}$  medium strength screwlock

ALLTRACK, ALLTRACK 4 & TREKKING 3 (MY24)







date: 24-10-2023

version: 01

**ASSEMBLY DRAWING**  
**SERVICE FILE**

**rear frame**



BOM-ID	QTY	Description	Specification	Torque	Service Kit
38	1	Hanger nut		20 Nm	 bike parts
39	1	Hanger			 bike parts
40	2	Cable guide for 1 cable			
41	2	Cable guide for 2 cables			
42	4	Lens head screw	IS3 - M5 x 12 mm	6 Nm	
43	1	Kickstand adaptor			 bike parts
44	2	Counter sunk screw	IS4 - M6 x 12 mm	11 Nm	 bike parts
45	1	Connection plates for standard after market carrier and/or fender (set right side + left side) ➤ <b>only for ALLTRACK models</b>			 bike parts
46	2	Counter sunk screw for connection plates ➤ <b>only for ALLTRACK models</b>	TX30 - M6 x 12 mm	11 Nm	 bike parts
47	1	Chainstay adapter for speed sensor			BOSCH EB11.200.016

ALLTRACK, ALLTRACK 4 & TREKKING 3 (MY24)

date: 24-10-2023

version: 01

**ASSEMBLY DRAWING**  
**SERVICE FILE**

**TREKKING 3 carrier & fender**

**HAIBIKE**

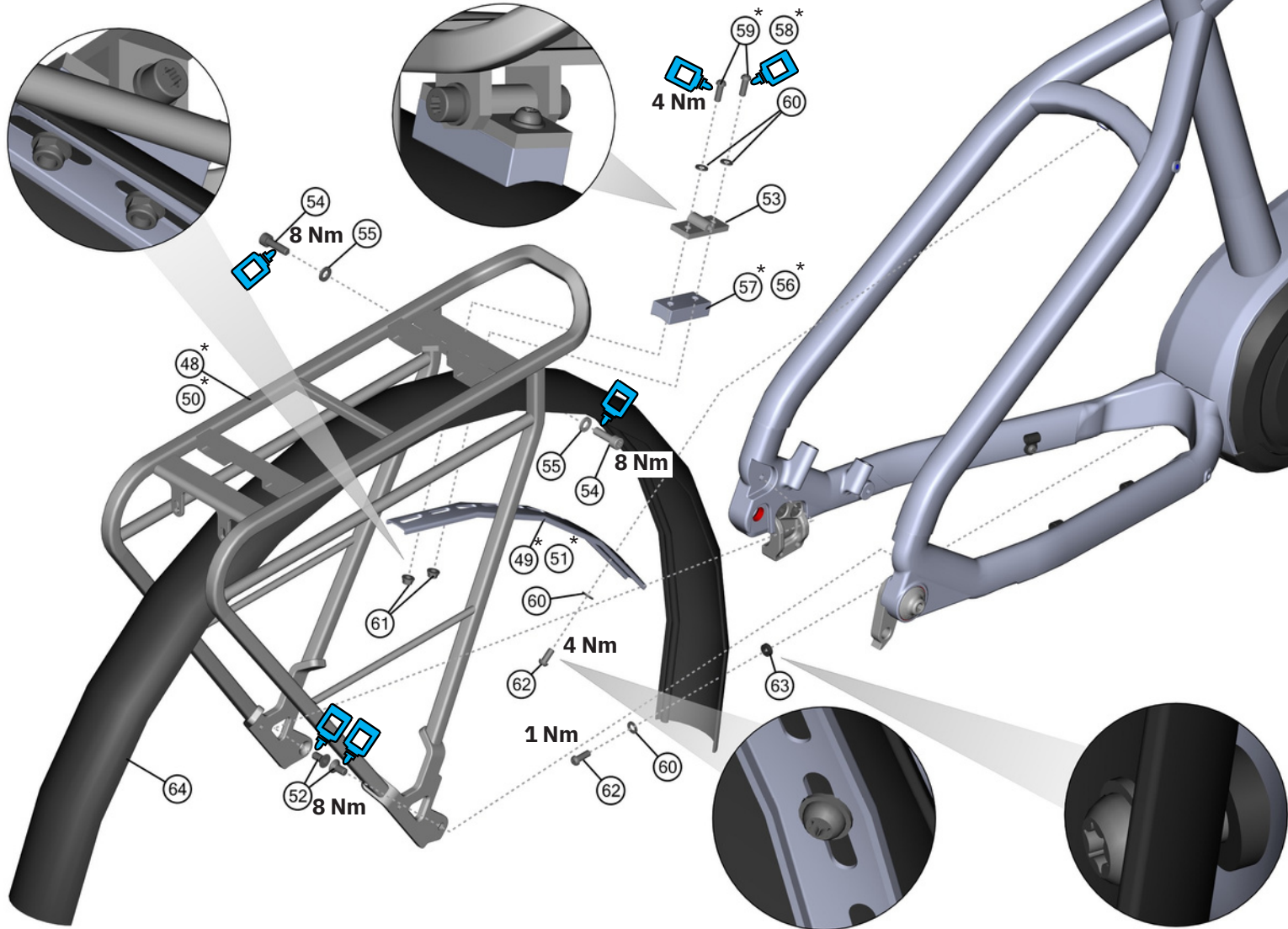

**Hinweis:** Bei den Schrauben muss mittelfeste Gewindegewinde verwendet werden.  
Rote Flächen müssen gefettet werden.

**Note:** use medium strength screw lock for screw threads.  
Red surfaces have to be greased.

 3/4 medium strength screwlock











ALLTRACK, ALLTRACK 4 & TREKKING 3 (MY24)  
date: 24-10-2023  
version: 01

# ASSEMBLY DRAWING

## SERVICE FILE

### TREKKING 3 carrier & fender

# HAIBIKE

BOM-ID	QTY	Description	Specification	Torque	Service Kit
48*	1	Carrier <b>(depending which is installed)</b>			KHB00056  
49*	1	Carrier rail <b>(depending which is installed)</b>			KHB00056  
50*	1	Carrier <b>(depending which is installed)</b>			KHB00056  
51*	1	Carrier rail <b>(depending which is installed)</b>			KHB00056  
52	2	Counter sunk screw	TX30 - M6 x 14 mm (8.8)	8 Nm	
53	1	Plate for carrier			
54	2	Hexagon socket screw (flat head)	IS4 - M6 x 14 mm (8.8)	8 Nm	
55	2	Washer	ø 6,4 mm		
56*	1	Carrier spacer 5mm <b>(depending which is installed)</b>			
57*	1	Carrier spacer 10mm <b>(depending which is installed)</b>			
58*	2	Lens head screw for 5mm carrier spacer <b>(depending which is installed)</b>	IS3 - M5 x 20 mm (10.9)	4 Nm	
59*	2	Lens head screw for 10mm carrier spacer <b>(depending which is installed)</b>	IS3 - M5 x 25 mm (10.9)	4 Nm	
60	4	Washer	ø 5,3 mm		
61	2	Self locking nut with flange	M5		
62	2	Lens head screw	TX25 - M5 x 14 mm (8.8)	1 & 4 Nm see drawing	
63	1	Plastic spacer	ø 5,2 x 10 x 8 mm		
64	1	Fender front & rear 27,5" + (Set)			KHB00055  

ALLTRACK, ALLTRACK 4 & TREKKING 3 (MY24)

date: 24-10-2023

version: 01

# ASSEMBLY DRAWING SERVICE

# HAIBIKE

FILE	FACT
<b>SHEET:</b>	
SHOCK LENGTH:	-----
SHOCK HARDWARE TOP:	-----
SHOCK HARDWARE BOTTOM:	-----
HEADSET TOP:	ZS 44
HEADSET BOTTOM:	ZS 56
SEATPOST DIAMETER:	31,6 mm
CLAMP INNER DIAMETER:	34,9 mm
BOTTOM BRACKET:	BB spindle BNI (mini
KICKSTAND:	ISIS) KSA18 (Adapter
ISCG STANDARD:	required) -----
CARRIER MOUNT:	YES (Adapter required)
FENDER COMPATIBLE:	YES

DROPPER SEATPOST READY:	NO
WATTERBOTTLE MOUNT:	1 x 0,75 L
MAXIMUM PERMISSIBLE TOTAL	ALLTRACK: 120 KG (CAT. 3) TREKKING: 130 KG (CAT. 2)
WEIGHT: MAXIMUM TIRE SIZE:	ALLTRACK: 65-584 / 65-622 TREKKING: 62-584
WHEEL SIZE:	ALLTRACK S / M: 27,5" ALLTRACK M / L / XL: 29" TREKKING: 27,5"
QUICK RELEASE LENGTH:	Thru-axle M12xP1.00x169mm / 148mm Head HEX Syntace
OVER-LOCKNUT DIMENSION (O.L.D.):	148 x 12 mm
FD CLAMP SIZE:	-----
FD TYPE:	-----
ENGINE:	BOSCH Smart System Performance Line
BATTERY:	BOSCH PowerTube 500Wh
DISPLAY:	BOSCH LED Remote + Intuvia 100 (Trekking only)

ALLTRACK, ALLTRACK 4 & TREKKING 3 (MY24)

date: 24-10-2023

version: 01